

Approval body for construction products  
and types of construction

Bautechnisches Prüfamt

An institution established by the Federal and  
Laender Governments



## European Technical Assessment

**ETA-15/0514**  
**of 15 September 2021**

English translation prepared by DIBt - Original version in German language

### General Part

Technical Assessment Body issuing the  
European Technical Assessment:

Deutsches Institut für Bautechnik

Trade name of the construction product

TSM high performance, TSM high performance A4,  
TSM high performance HCR

Product family  
to which the construction product belongs

Mechanical fasteners for use in concrete

Manufacturer

TOGE Dübel GmbH & Co. KG  
Illesheimer Straße 10  
90431 Nürnberg  
DEUTSCHLAND

Manufacturing plant

TOGE Dübel GmbH & Co. KG

This European Technical Assessment  
contains

22 pages including 3 annexes which form an integral part  
of this assessment

This European Technical Assessment is  
issued in accordance with Regulation (EU)  
No 305/2011, on the basis of

EAD 330232-00-0601, Edition 10/2016

This version replaces

ETA-15/0514 issued on 22 September 2020

The European Technical Assessment is issued by the Technical Assessment Body in its official language. Translations of this European Technical Assessment in other languages shall fully correspond to the original issued document and shall be identified as such.

Communication of this European Technical Assessment, including transmission by electronic means, shall be in full. However, partial reproduction may only be made with the written consent of the issuing Technical Assessment Body. Any partial reproduction shall be identified as such.

This European Technical Assessment may be withdrawn by the issuing Technical Assessment Body, in particular pursuant to information by the Commission in accordance with Article 25(3) of Regulation (EU) No 305/2011.

## Specific Part

### 1 Technical description of the product

The TOGE Concrete screw TSM high performance is an anchor in size 6, 8, 10, 12 and 14 mm made of galvanised steel respectively steel with zinc flake coating, made of stainless or high corrosion resistant steel. The anchor is screwed into a predrilled cylindrical drill hole. The special thread of the anchor cuts an internal thread into the member while setting. The anchorage is characterised by mechanical interlock in the special thread.

Product and product description are given in Annex A.

### 2 Specification of the intended use in accordance with the applicable European Assessment Document

The performances given in Section 3 are only valid if the anchor is used in compliance with the specifications and conditions given in Annex B.

The verifications and assessment methods on which this European Technical Assessment is based lead to the assumption of a working life of the anchor of at least 50 years. The indications given on the working life cannot be interpreted as a guarantee given by the producer, but are to be regarded only as a means for choosing the right products in relation to the expected economically reasonable working life of the works.

### 3 Performance of the product and references to the methods used for its assessment

#### 3.1 Mechanical resistance and stability (BWR 1)

Essential characteristic	Performance
Characteristic resistance to tension load (static and quasi-static loading)	See Annex C 1 and C 2
Characteristic resistance to shear load (static and quasi-static loading)	See Annex C 1 and C 2
Displacements (static and quasi-static loading)	See Annex C 7
Characteristic resistance and displacements for seismic performance categories C1 and C2	See Annex C 3, C 4, C 5 and C 8
Durability	See Annex B 1

#### 3.2 Safety in case of fire (BWR 2)

Essential characteristic	Performance
Reaction to fire	Class A1
Resistance to fire	See Annex C 6

English translation prepared by DIBt

**4 Assessment and verification of constancy of performance (AVCP) system applied, with reference to its legal base**

In accordance with European Assessment Document EAD No. 330232-00-0601 the applicable European legal act is: [96/582/EC].

The system to be applied is: 1

**5 Technical details necessary for the implementation of the AVCP system, as provided for in the applicable European Assessment Document**

Technical details necessary for the implementation of the AVCP system are laid down in the control plan deposited at Deutsches Institut für Bautechnik.

Issued in Berlin on 15 September 2021 by Deutsches Institut für Bautechnik

Dipl.-Ing. Beatrix Wittstock  
Head of Section

*beglaubigt:*  
Tempel

## Product in installed condition

### TOGE concrete screw TSM high performance

- Galvanized carbon steel
- Zinc flakes coated carbon steel

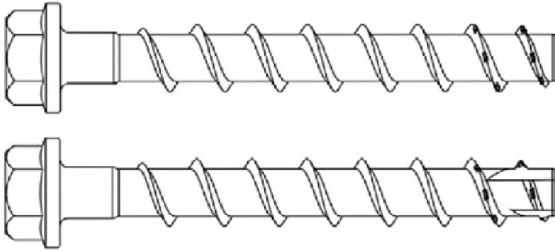

- Stainless steel A4
- Stainless steel HCR

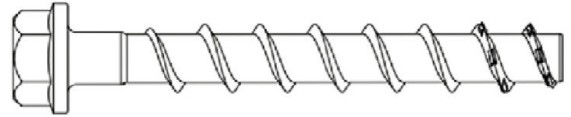

e.g. TOGE concrete screw, zinc flakes coated, with hexagon head and fixture

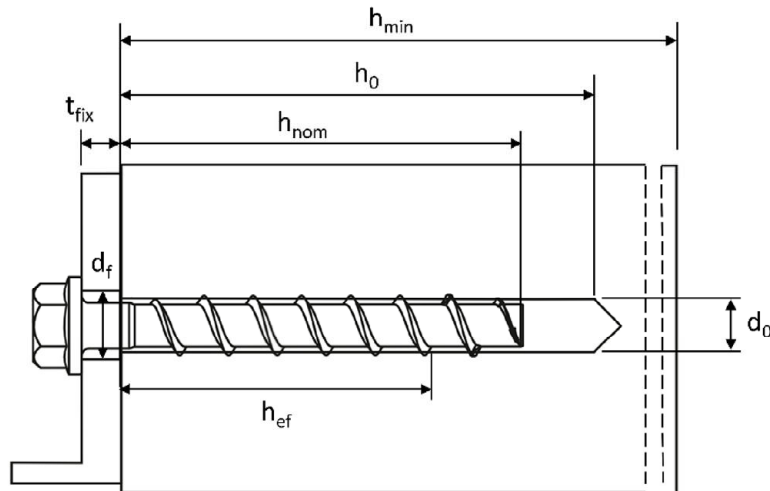

$d_0$  = nominal drill hole diameter  
 $t_{fix}$  = thickness of fixture  
 $d_f$  = clearance hole diameter

$h_{min}$  = minimum thickness of member  
 $h_{nom}$  = nominal embedment depth  
 $h_0$  = drill hole depth  
 $h_{ef}$  = effective embedment depth

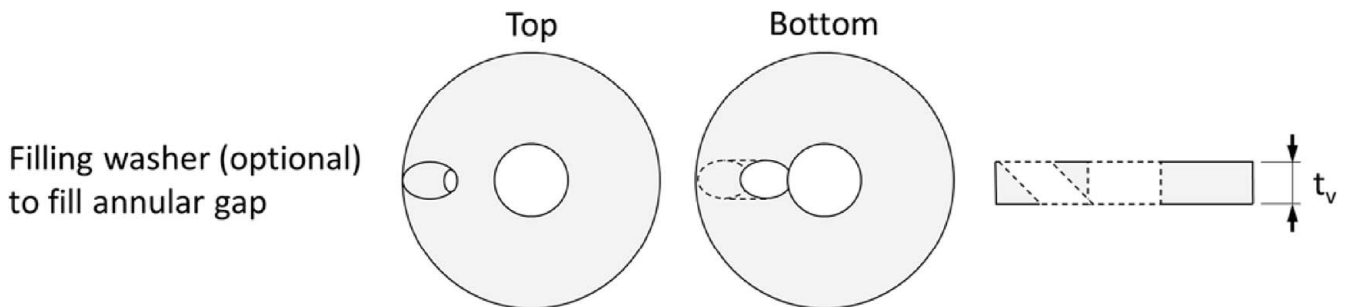









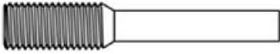



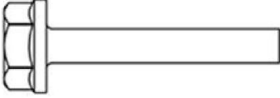





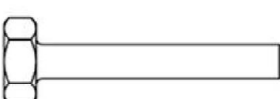

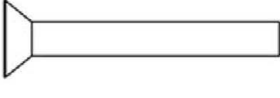

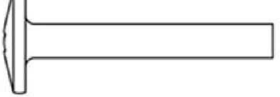

Filling washer (optional)  
to fill annular gap

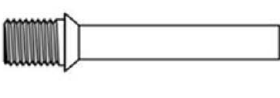
TOGE concrete screw TSM high performance

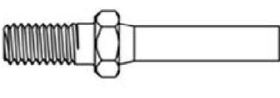
**Product description**  
Product in installed condition

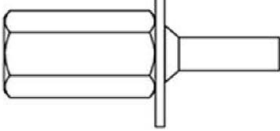
**Annex A1**

		Configuration with metric connection thread and hexagon socket e.g. TSM 8x105 M10 SW5; Type ST
		Configuration with metric connection thread and hexagon drive e.g. TSM 8x105 M10 SW7; Type ST
		Configuration with washer and hexagon head e.g. TSM 8x80 SW13 VZ 40; Type S
		Configuration with washer, hexagon head and TORX drive e.g. TSM 8x80 SW13; Type S
		Configuration with washer and bund e.g. TSM BC ST 14x130 SW24 VZ 40; Type BND
		Configuration with hexagon head e.g. TSM 8x80 SW13 OS; Type S
		Configuration with countersunk head and TORX drive e.g. TSM 8x80 C VZ 40; Type SK
		Configuration with pan head and TORX drive e.g. TSM 8x80 P VZ 40; Type P
		Configuration with large pan head and TORX drive e.g. TSM 8x80 LP VZ 40; Type P
		Configuration with countersunk head and connection thread e.g. TSM 6x55 AG M8; Type ST-6
		Configuration with hexagon drive and connection thread e.g. TSM 6x55 M8 SW10; Type ST-6
		Configuration with internal thread and hexagon drive e.g. TSM 6x55 IM M8/10; Type I

TOGE concrete screw TSM high performance

**Product description**  
Screw types

**Annex A2**

Table 1: Material

Part	Product name	Material		
all types	TSM high performance	- Steel EN 10263-4:2017 galvanized acc. to EN ISO 4042:2018 - Zinc flake coating according to EN ISO 10683:2018 ( $\geq 5\mu\text{m}$ ) - Zinc flake coating according to EN ISO 10683:2018 special coating TOGE KORR ( $\geq 20\mu\text{m}$ )		
	TSM high performance A4	1.4401; 1.4404; 1.4571; 1.4578		
	TSM high performance HCR	1.4529		
Part	Product name	Nominal characteristic steel		Rupture elongation
		Yield strength	Ultimate strength	$A_5$ [%]
		$f_{yk}$ [N/mm <sup>2</sup> ]	$f_{uk}$ [N/mm <sup>2</sup> ]	
all types	TSM high performance	560	700	$\leq 8$
	TSM high performance A4			
	TSM high performance HCR			

Table 2: Dimensions

Anchor size			6		8			10			12			14		
Nominal embedment depth	$h_{nom}$	[mm]	1	2	1	2	3	1	2	3	1	2	3	1	2	3
		[mm]	40	55	45	55	65	55	75	85	65	85	100	75	100	115
Screw length	$\leq L$	[mm]	500													
Core diameter	$d_k$	[mm]	5,1		7,1			9,1			11,1			13,1		
Thread outer diameter	$d_s$	[mm]	7,5		10,6			12,6			14,6			16,6		
Thickness of filling washer	$t_v$	[mm]	-		5			5			5			5		

**Marking:**

**TSM high performance**

Screw type: TSM  
Screw size: 10  
Screw length: 100



**TSM high performance A4**

Screw type: TSM  
Screw size: 10  
Screw length: 100  
Material: A4



**TSM high performance BC ST**

Screw type: TSM BC ST  
Screw size: 10  
Screw length: 100



**TSM high performance HCR**

Screw type: TSM  
Screw size: 10  
Screw length: 100  
Material: HCR

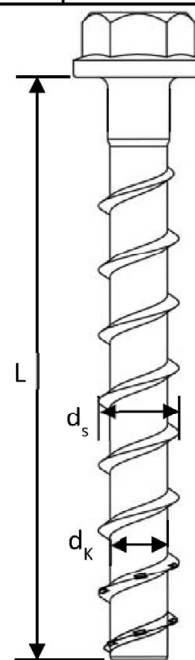
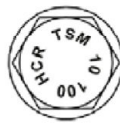

TOGE concrete screw TSM high Performance

**Product description**  
Material, Dimensions and markings

**Annex A3**

## Specification of Intended use

Table 3: Anchorages subject to

TSM concrete screw size		6		8			10			12			14		
Nominal embedment depth		$h_{nom1}$	$h_{nom2}$	$h_{nom1}$	$h_{nom2}$	$h_{nom3}$	$h_{nom1}$	$h_{nom2}$	$h_{nom3}$	$h_{nom1}$	$h_{nom2}$	$h_{nom3}$	$h_{nom1}$	$h_{nom2}$	$h_{nom3}$
	[mm]	40	55	45	55	65	55	75	85	65	85	100	65	85	115
Static and quasi-static loads		All sizes and all embedment depths													
Fire exposure															
C1 category - seismic		ok	ok				ok								
C2 category – seismic (A4 and HCR: no performance assessed)		1)		1)		ok	1)	1)	ok	1)		ok	1)		ok

1) no performance assessed

### Base materials:

- Compacted reinforced and unreinforced concrete without fibers according to EN 206:2013.
- Strength classes C20/25 to C50/60 according to EN 206:2013.
- Cracked and uncracked concrete.

### Use conditions (Environmental conditions):

- Concrete screws subject to dry internal conditions: all screw types.
- Structural subject to external atmospheric exposure (including industrial and marine environment) and to permanently damp internal condition no particular aggressive conditions exists: screw types made of stainless steel with marking A4.
- Structural subject to external atmospheric exposure (including industrial and marine environment) and to permanently damp internal condition if particular aggressive conditions exists: screw types made of stainless steel with marking HCR.

Note: Such particular aggressive conditions are e.g. permanent, alternating immersion in seawater or splash zone of seawater, chloride atmosphere of indoor swimming pools or atmosphere with chemical pollution (e.g. in desulphurization plants or road tunnels where de-icing materials are used).

TOGE concrete screw TSM high Performance

Intended use  
Specification

Annex B1



## Specification of Intended use - continuation

### Design:

- Anchorages are to be designed under the responsibility of an engineer experienced in anchorages and concrete work.
- Verifiable calculation notes and drawings are to be prepared taking account of the loads to be anchored. The position of the anchor is indicated on the design drawings (e.g. position of the anchor relative to reinforcement or to supports, etc.).
- Anchorages are designed according to EN 1992-4:2018 and EOTA Technical Report TR 055. The design for shear load according to EN 1992-4:2018, Section 6.2.2 applies for all specified diameters  $d_f$  of clearance hole in the fixture in Annex B3, Table 4.

### Installation:

- Hammer drilling or hollow drilling.
- Anchor installation carried out by appropriately qualified personnel and under the supervision of the person responsible for technical matters on site.
- In case of aborted hole: new drilling must be drilled at a minimum distance of twice the depth of aborted hole or closer, if the aborted hole is filled with high strength mortar and only if the hole is not in the direction of the oblique tensile or shear load.
- After installation further turning of the anchor must not be possible. The head of the anchor is supported in the fixture and is not damaged.
- The borehole may be filled with injection mortar CF-T 300V or ATA 2004C.
- Adjustability according to Annex B6 for sizes 6-14, all embedment depths except for applications with filled borehole and not for seismic applications.
- Cleaning of borehole is not necessary, if using a hollow drill.

**TOGE concrete screw TSM high Performance**

**Intended use**  
Specification continuation

**Annex B2**

Table 4: Installation parameters

TSM concrete screw size		6		8			10		
Nominal embedment depth	$h_{nom}$	$h_{nom1}$	$h_{nom2}$	$h_{nom1}$	$h_{nom2}$	$h_{nom3}$	$h_{nom1}$	$h_{nom2}$	$h_{nom3}$
	[mm]	40	55	45	55	65	55	75	85
Nominal drill hole diameter	$d_0$	6		8			10		
Cutting diameter of drill bit	$d_{cut} \leq$	6,40		8,45			10,45		
Drill hole depth	$h_0 \geq$	45	60	55	65	75	65	85	95
Clearance hole diameter	$d_f \leq$	8		12			14		
Installation torque (version with connection thread)	$T_{inst}$	10		20			40		
Torque impact screw driver	[Nm]	Max. torque according to manufacturer's instructions							
		160		300			400		

TSM concrete screw size		12			14		
Nominal embedment depth	$h_{nom}$	$h_{nom1}$	$h_{nom2}$	$h_{nom3}$	$h_{nom1}$	$h_{nom2}$	$h_{nom3}$
	[mm]	65	85	100	75	100	115
Nominal drill hole diameter	$d_0$	12			14		
Cutting diameter of drill bit	$d_{cut} \leq$	12,50			14,50		
Drill hole depth	$h_0 \geq$	75	95	110	85	110	125
Clearance hole diameter	$d_f \leq$	16			18		
Installation torque (version with connection thread)	$T_{inst}$	60			80		
Torque impact screw driver	[Nm]	Max. torque according to manufacturer's instructions					
		650			650		

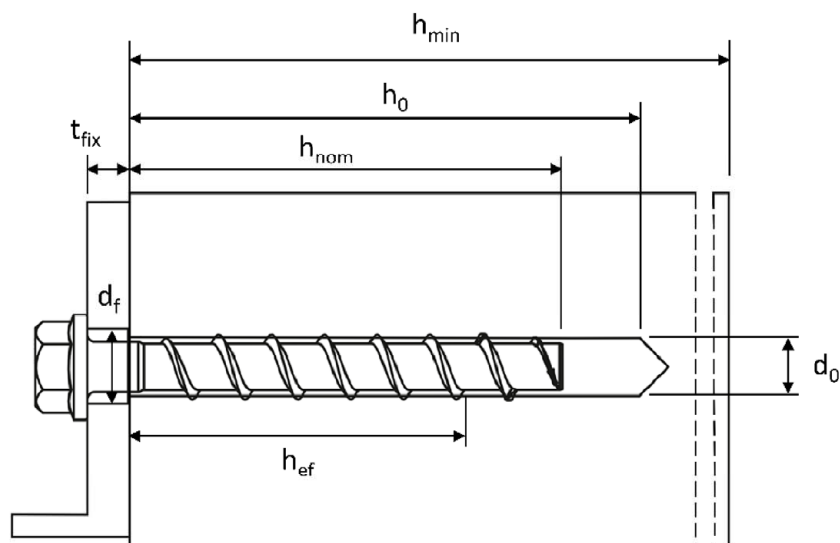

TOGE concrete screw TSM high Performance

Intended use  
Installation parameters

Annex B3

Table 5: Minimum thickness of member, minimum edge distance and minimum spacing

TSM concrete screw size		6			8			10		
Nominal embedment depth	$h_{nom}$	$h_{nom1}$	$h_{nom2}$	$h_{nom1}$	$h_{nom2}$	$h_{nom3}$	$h_{nom1}$	$h_{nom2}$	$h_{nom3}$	
	[mm]	40	55	45	55	65	55	75	85	
Minimum thickness of member	$h_{min}$	[mm]	100		100		120	100	130	
Minimum edge distance	$c_{min}$	[mm]	40	40	50		50			
Minimum spacing	$s_{min}$	[mm]	40	40	50		50			

TSM concrete screw size		12			14			
Nominal embedment depth	$h_{nom}$	$h_{nom1}$	$h_{nom2}$	$h_{nom3}$	$h_{nom1}$	$h_{nom2}$	$h_{nom3}$	
	[mm]	65	85	100	75	100	115	
Minimum thickness of member	$h_{min}$	[mm]	120	130	150	130	150	170
Minimum edge distance	$c_{min}$	[mm]	50		70	50	70	
Minimum spacing	$s_{min}$	[mm]	50		70	50	70	

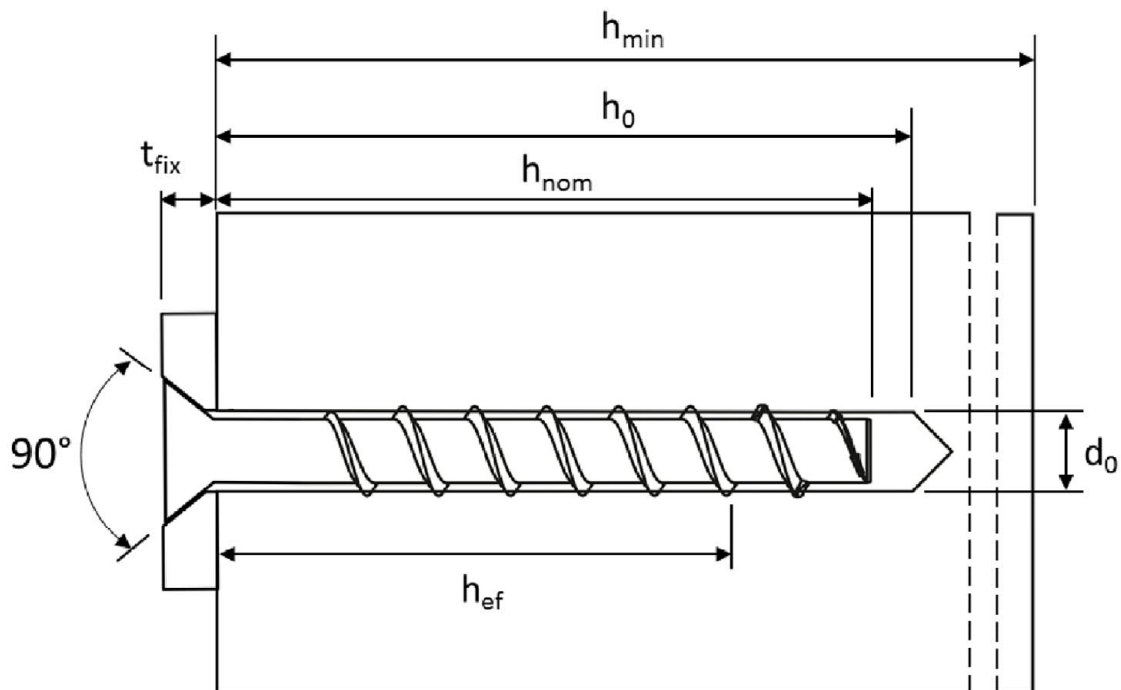

**TOGE concrete screw TSM high Performance**

**Intended use**

Minimum thickness of member, minimum edge distance and minimum spacing

**Annex B4**

## Installation Instructions

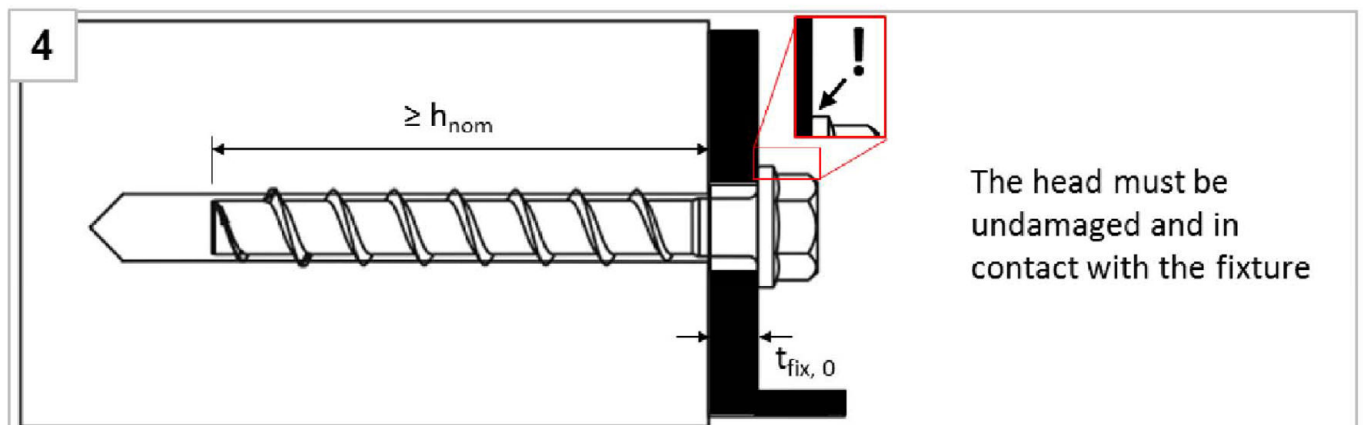
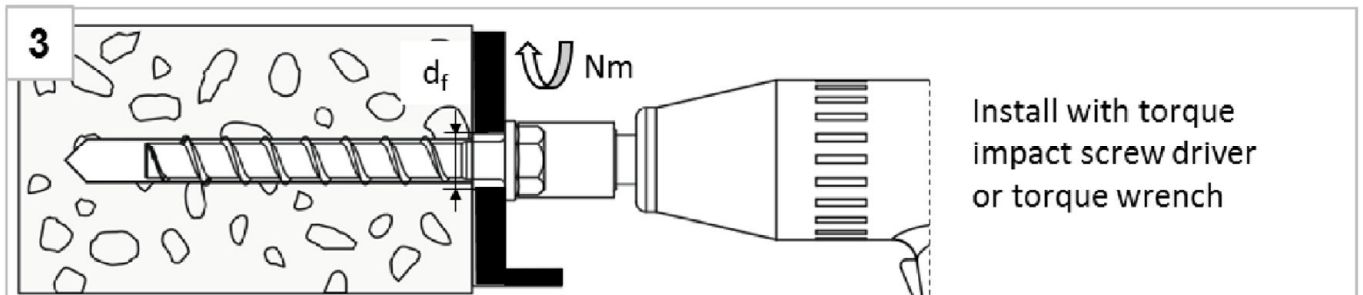
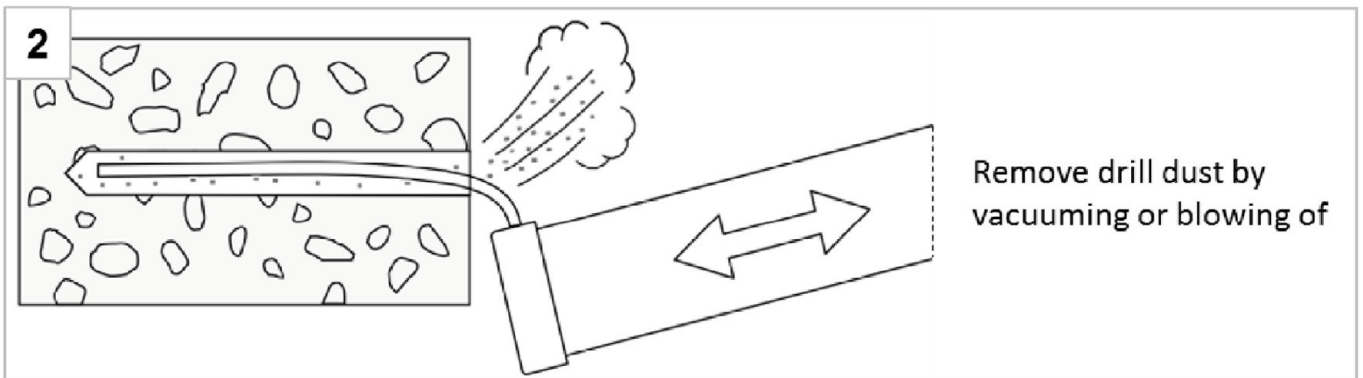
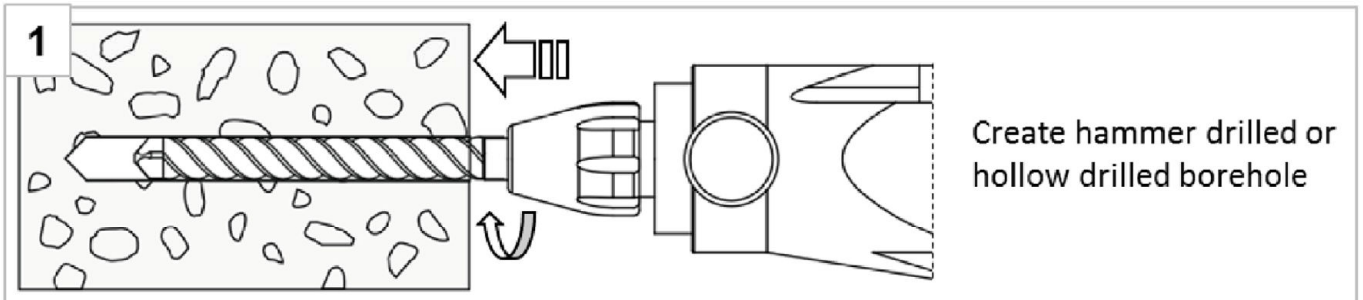

**Note:**

Cleaning of borehole is not necessary when using a hollow drill

**TOGE concrete screw TSM high Performance**

**Intended use**  
Installation instructions

**Annex B5**

## Installation Instructions – Adjustment

### 1. Adjustment

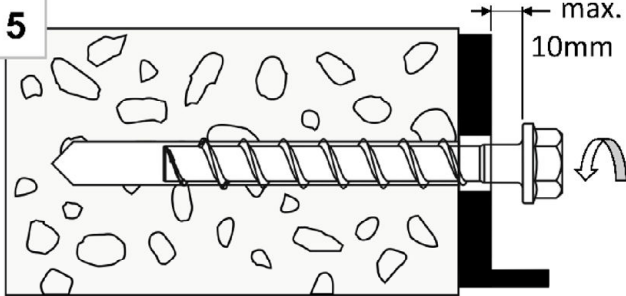

Screw may be untightened maximum 10mm

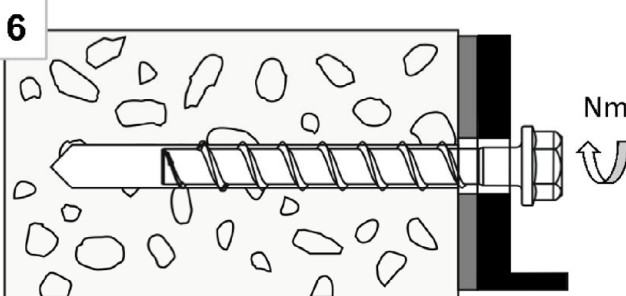

After adjustment, tighten the screw again

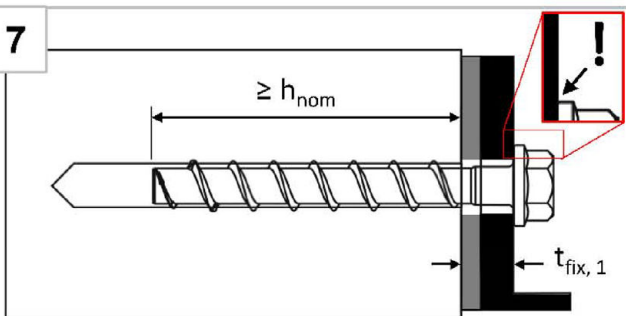

The head must be undamaged and in contact with the fixture

### 2. Adjustment

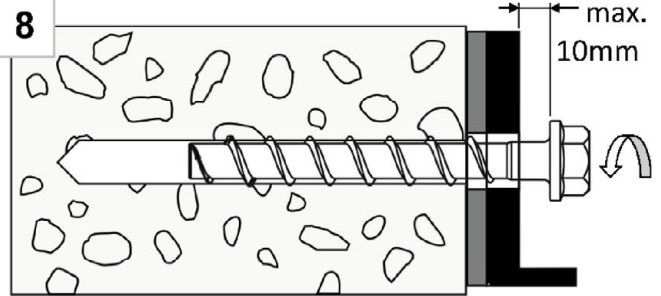

Screw may be untightened maximum 10mm

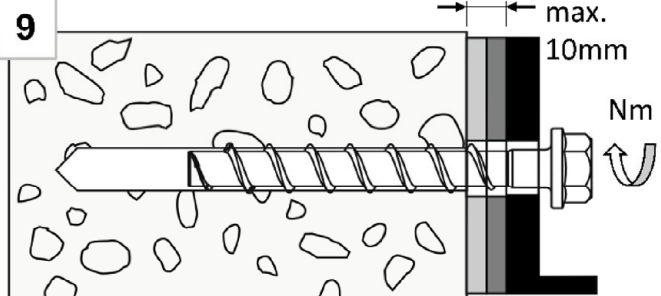

After adjustment, tighten the screw again

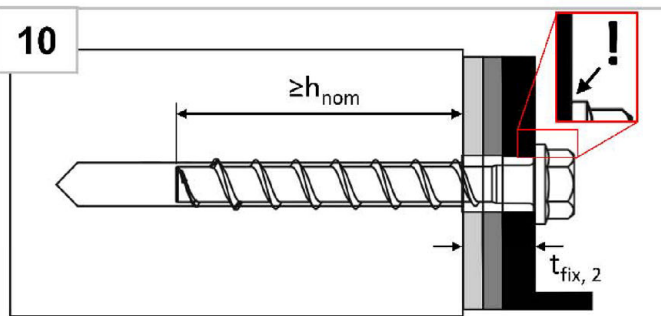

The head must be undamaged and in contact with the fixture

**Note:**

The fastener can be adjusted maximum two times. The total allowed thickness of shims added during the adjustment process is 10mm. The final embedment depth after adjustment process must be larger or equal than  $h_{nom}$ .

**TOGE concrete screw TSM high Performance**

**Intended use**  
Installation instructions - Adjustment

**Annex B6**

## Installation Instructions – Filling annular gap

### Positioning of fixture and filling washer

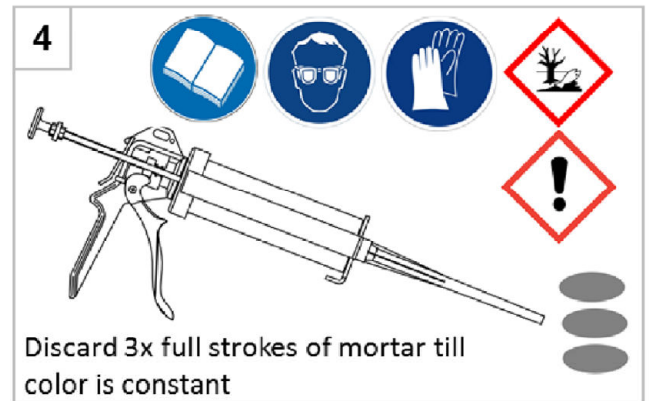
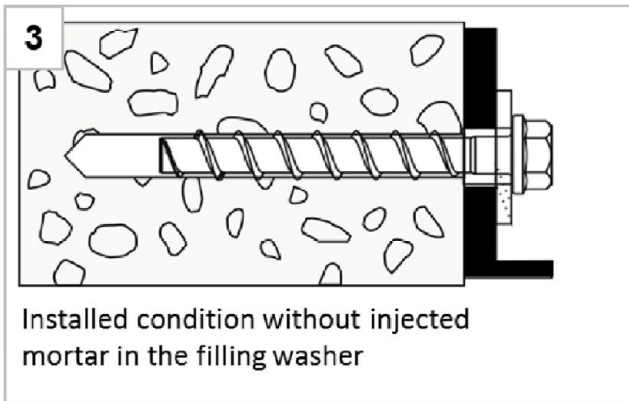
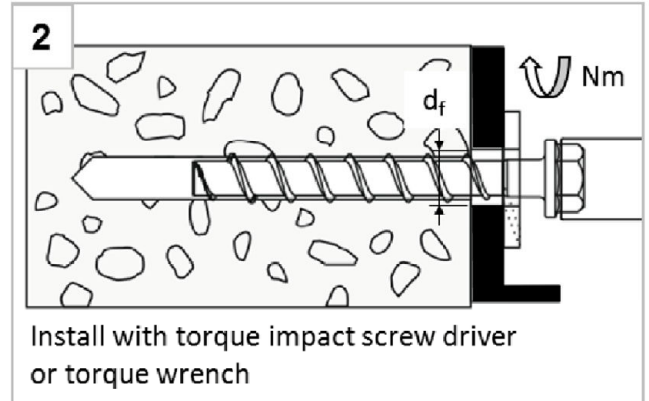
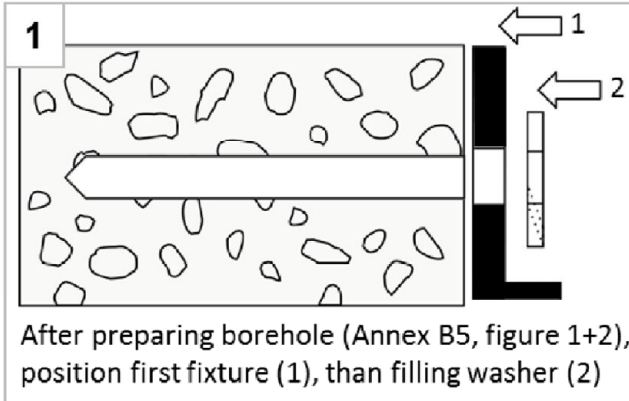

### Filling the annular gap

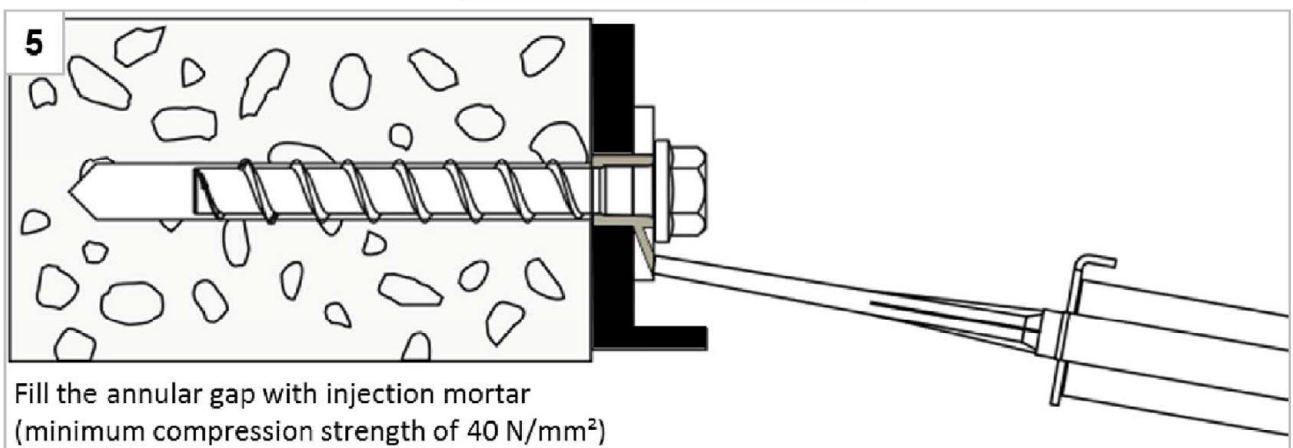

Note:

For seismic loading the installation with filled and without filled annular gap is approved. Differences in performance can be found in Annex C5 - C7.

**TOGE concrete screw TSM high Performance**

**Intended use**  
Installation instructions - Filling annular gap

**Annex B7**

Table 6: Characteristic values for static and quasi-static loading, sizes 6-10

TSM concrete screw size			6		8			10			
Nominal embedment depth	$h_{nom}$	$h_{nom1}$	$h_{nom2}$	$h_{nom1}$	$h_{nom2}$	$h_{nom3}$	$h_{nom1}$	$h_{nom2}$	$h_{nom3}$		
	[mm]	40	55	45	55	65	55	75	85		
<b>Steel failure for tension and shear loading</b>											
Characteristic tension load	$N_{RK,S}$	[kN]	14,0		27,0			45,0			
Partial factor	$\gamma_{Ms,N}$	[-]	1,5								
Characteristic shear load	$V^0_{RK,S}$	[kN]	7,0		13,5		17,0	22,5	34,0		
Partial factor	$\gamma_{Ms,V}$	[-]	1,25								
Ductility factor	$k_7$	[-]	0,8								
Characteristic bending load	$M^0_{RK,S}$	[Nm]	10,9		26,0			56,0			
<b>Pull-out failure</b>											
Characteristic tension load C20/25	cracked	$N_{RK,p}$	[kN]	2,0	4,0	5,0	9,0	12,0	9,0	$\geq N^0_{RK,c}$ <sup>1)</sup>	
	uncracked	$N_{RK,p}$	[kN]	4,0	9,0	7,5	12,0	16,0	12,0	20,0	26,0
Increasing factor for $N_{RK,p}$	C25/30	$\Psi_c$	[-]	1,12							
	C30/37			1,22							
	C40/50			1,41							
	C50/60			1,58							
<b>Concrete failure: Splitting failure, concrete cone failure and pry-out failure</b>											
Effective embedment depth	$h_{ef}$	[mm]	31	44	35	43	52	43	60	68	
k-factor	cracked	$k_{cr}$	[-]	7,7							
	uncracked	$k_{ucr}$	[-]	11,0							
Concrete cone failure	spacing	$s_{cr,N}$	[mm]	3 x $h_{ef}$							
	edge distance	$c_{cr,N}$	[mm]	1,5 x $h_{ef}$							
Splitting failure	resistance	$N^0_{RK,sp}$	[kN]	4,0	9,0	7,5	12,0	16,0	12,0	20,0	26,0
	spacing	$s_{cr,sp}$	[mm]	120	160	120	140	150	140	180	210
	edge distance	$c_{cr,sp}$	[mm]	60	80	60	70	75	70	90	105
Factor for pry-out failure	$k_8$	[-]	1,0						2,0		
Installation factor	$\gamma_{inst}$	[-]	1,0								
<b>Concrete edge failure</b>											
Effective length in concrete	$l_f = h_{ef}$	[mm]	31	44	35	43	52	43	60	68	
Nominal outer diameter of screw	$d_{nom}$	[mm]	6		8			10			
<sup>1)</sup> $N^0_{RK,c}$ according to EN 1992-4:2018											
<b>TOGE concrete screw TSM high Performance</b>									<b>Annex C1</b>		
<b>Performances</b> Characteristic values for static and quasi-static loading, sizes 6-10											

Table 7: Characteristic values for static and quasi-static loading, sizes 12-14

TSM concrete screw size			12			14			
Nominal embedment depth	$h_{nom}$		$h_{nom1}$	$h_{nom2}$	$h_{nom3}$	$h_{nom1}$	$h_{nom2}$	$h_{nom3}$	
	[mm]		65	85	100	75	100	115	
<b>Steel failure for tension and shear loading</b>									
Characteristic tension load	$N_{RK,s}$	[kN]	67,0			94,0			
Partial factor	$\gamma_{Ms,N}$	[-]	1,5						
Characteristic shear load	$V_{RK,s}^0$	[kN]	33,5	42,0		56,0			
Partial factor	$\gamma_{Ms,V}$	[-]	1,25						
Ductility factor	$k_7$	[-]	0,8						
Characteristic bending load	$M_{RK,s}^0$	[Nm]	113,0			185,0			
<b>Pull-out failure</b>									
Characteristic tension load C20/25	cracked	$N_{RK,p}$	[kN]	12,0	$\geq N_{RK,c}^0$ <sup>1)</sup>				
	uncracked	$N_{RK,p}$	[kN]	16,0					
Increasing factor for $N_{RK,p}$	C25/30	$\psi_c$	[-]	1,12					
	C30/37			1,22					
	C40/50			1,41					
	C50/60			1,58					
<b>Concrete failure: Splitting failure, concrete cone failure and pry-out failure</b>									
Effective embedment depth	$h_{ef}$	[mm]	50	67	80	58	79	92	
k-factor	cracked	$k_1 = k_{cr}$	[-]	7,7					
	uncracked	$k_1 = k_{ucr}$	[-]	11,0					
Concrete cone failure	spacing	$s_{cr,N}$	[mm]	$3 \times h_{ef}$					
	edge distance	$c_{cr,N}$	[mm]	$1,5 \times h_{ef}$					
Splitting failure	resistance	$N_{RK,sp}^0$	[kN]	16,0	27,0	35,0	21,5	34,5	43,5
	spacing	$s_{cr,sp}$	[mm]	150	210	240	180	240	280
	edge distance	$c_{cr,sp}$	[mm]	75	105	120	90	120	140
Factor for pry-out failure	$k_8$	[-]	1,0	2,0		1,0	2,0		
Installation factor	$\gamma_{inst}$	[-]	1,0						
<b>Concrete edge failure</b>									
Effective length in concrete	$l_f = h_{ef}$	[mm]	50	67	80	58	79	92	
Nominal outer diameter of screw	$d_{nom}$	[mm]	12			14			

<sup>1)</sup>  $N_{RK,c}^0$  according to EN 1992-4:2018

**TOGE concrete screw TSM high Performance**

**Performances**

Characteristic values for static and quasi-static loading, sizes 12-14

**Annex C2**



Table 8: Seismic category C1 – Characteristic load values (type S, type SK, type ST, type ST-6<sup>1)</sup>, type P and type I<sup>1)</sup>)

TSM concrete screw size			6	8	10	12	14		
Nominal embedment depth	$h_{nom}$		$h_{nom1}$	$h_{nom2}$	$h_{nom3}$	$h_{nom1}$	$h_{nom3}$	$h_{nom3}$	
	[mm]		40	55	65	55	85	100	115
<b>Steel failure for tension and shear load (version type S, type SK, type ST, type ST-6<sup>1)</sup>, type P, type I<sup>1)</sup>)</b>									
Characteristic load	$N_{Rk,s,eq}$	[kN]	14,0	27,0	45,0	67,0	94,0		
Partial factor	$\gamma_{Ms,eq}$	[-]	1,5						
Characteristic load	$V_{Rk,s,eq}$	[kN]	4,7	5,5	8,5	13,5	15,3	21,0	22,4
Partial factor	$\gamma_{Ms,eq}$	[-]	1,25						
With filling of the annular gap <sup>2)</sup>	$\alpha_{gap}$	[-]	1,0						
Without filling of the annular gap <sup>3)</sup>	$\alpha_{gap}$	[-]	0,5						
<b>Pull-out failure (version type S, type SK, type ST, type ST-6<sup>1)</sup>, type P, type I<sup>1)</sup>)</b>									
Characteristic tension load in cracked concrete C20/25	$N_{Rk,p,eq}$	[kN]	2,0	4,0	12,0	9,0	$\geq N_{Rk,c}^0$ <sup>4)</sup>		
<b>Concrete cone failure (version type S, type SK, type ST, type ST-6<sup>1)</sup>, type P, type I<sup>1)</sup>)</b>									
Effective embedment depth	$h_{ef}$	[mm]	31	44	52	43	68	80	92
Edge distance	$c_{cr,N}$	[mm]	1,5 x $h_{ef}$						
Spacing	$s_{cr,N}$	[mm]	3 x $h_{ef}$						
Installation safety factor	$\gamma_{inst}$	[-]	1,0						
<b>Concrete pry-out failure (version type S, type SK, type ST, type P)</b>									
Factor for pry-out failure	$k_8$	[-]	1,0			2,0			
<b>Concrete edge failure (version type S, type SK, type ST, type P)</b>									
Effective length in concrete	$l_f = h_{ef}$	[mm]	31	44	52	43	68	80	92
Nominal outer diameter of screw	$d_{nom}$	[mm]	6	6	8	10	10	12	14
<sup>1)</sup> only tension load <sup>2)</sup> With filling of the annular gap according to annex B7, figure 5 <sup>3)</sup> Without filling of the annular gap according to annex B5 <sup>4)</sup> $N_{Rk,c}^0$ according to EN 1992-4:2018									
<b>TOGE concrete screw TSM high Performance</b>							<b>Annex C3</b>		
<b>Performances</b> Seismic category C1 – Characteristic load values									

Table 9: Seismic category C2 <sup>1)</sup> – Characteristic load values with filled annular gap according to annex B7, figure 5 (type S, type ST, type P)

TSM concrete screw size			8	10	12	14
Nominal embedment depth	$h_{nom}$	$h_{nom3}$				
	[mm]	65	85	100	115	
<b>Steel failure for tension and shear load (version type S, type ST, type P)</b>						
Characteristic load	$N_{RK,s,eq}$	[kN]	27,0	45,0	67,0	94,0
Partial factor	$\gamma_{Ms,eq}$	[-]	1,5			
Characteristic load	$V_{RK,s,eq}$	[kN]	9,9	18,5	31,6	40,7
Partial factor	$\gamma_{Ms,eq}$	[-]	1,25			
With filling of the annular gap	$\alpha_{gap}$	[-]	1,0			
<b>Pull-out failure (version type S, type ST, type P)</b>						
Characteristic load in cracked concrete	$N_{RK,p,eq}$	[kN]	2,4	5,4	7,1	10,5
<b>Concrete cone failure (version type S, type ST, type P)</b>						
Effective embedment depth	$h_{ef}$	[mm]	52	68	80	92
Edge distance	$c_{cr,N}$	[mm]	$1,5 \times h_{ef}$			
Spacing	$s_{cr,N}$	[mm]	$3 \times h_{ef}$			
Installation safety factor	$\gamma_{inst}$	[-]	1,0			
<b>Concrete pry-out failure (version type S, type ST, type P)</b>						
Factor for pry-out failure	$k_g$	[-]	1,0	2,0		
<b>Concrete edge failure (version type S, type ST, type P)</b>						
Effective length in concrete	$l_f = h_{ef}$	[mm]	52	68	80	92
Nominal outer diameter of screw	$d_{nom}$	[mm]	8	10	12	14

1) A4 and HCR not suitable

**TOGE concrete screw TSM high Performance**

**Performances**

Seismic category C2 – Characteristic load values with filled annular gap

**Annex C4**

Table 10: Seismic category C2 <sup>1)</sup> – Characteristic load values **without filled annular gap according to annex B5** (type S, type ST, type P)

TSM concrete screw size			8	10	12	14
Nominal embedment depth	$h_{nom}$	$h_{nom3}$				
	[mm]	65	85	100	115	
<b>Steel failure for tension and shear load (version type S, type ST, type P)</b>						
Characteristic load	$N_{Rk,s,eq}$	[kN]	27,0	45,0	67,0	94,0
Partial factor	$\gamma_{Ms,eq}$	[-]	1,5			
Characteristic load	$V_{Rk,s,eq}$	[kN]	10,3	21,9	24,4	23,3
Partial factor	$\gamma_{Ms,eq}$	[-]	1,25			
Without filling of the annular gap	$\alpha_{gap}$	[-]	0,5			
<b>Pull-out failure (version type S, type ST, type P)</b>						
Characteristic load in cracked concrete	$N_{Rk,p,eq}$	[kN]	2,4	5,4	7,1	10,5
<b>Steel failure for tension and shear load (version type SK)</b>						
Characteristic load	$N_{Rk,s,eq}$	[kN]	27,0	45,0	no performance assessed	
Partial factor	$\gamma_{Ms,eq}$	[-]	1,5			
Characteristic load	$V_{Rk,s,eq}$	[kN]	3,6	13,7		
Partial factor	$\gamma_{Ms,eq}$	[-]	1,25			
Without filling of the annular gap	$\alpha_{gap}$	[-]	0,5			
<b>Pull-out failure (version type SK)</b>						
Characteristic load in cracked concrete	$N_{Rk,p,eq}$	[kN]	2,4	5,4	no performance assessed	
<b>Concrete cone failure (version type S, type SK, type ST, type P)</b>						
Effective embedment depth	$h_{ef}$	[mm]	52	68	80	92
Edge distance	$c_{cr,N}$	[mm]	$1,5 \times h_{ef}$			
Spacing	$s_{cr,N}$	[mm]	$3 \times h_{ef}$			
Installation safety factor	$\gamma_{inst}$	[-]	1,0			
<b>Concrete pry-out failure (version type S, type SK, type ST, type P)</b>						
Factor for pry-out failure	$k_g$	[-]	1,0	2,0		
<b>Concrete edge failure (version type S, type SK, type ST, type P)</b>						
Effective length in concrete	$l_f = h_{ef}$	[mm]	52	68	80	92
Nominal outer diameter of screw	$d_{nom}$	[mm]	8	10	12	14

<sup>1)</sup> A4 and HCR not suitable

**TOGE concrete screw TSM high Performance**

**Performances**

Seismic category C2 – Characteristic load values without filled annular gap

**Annex C5**

Table 11: Fire exposure – characteristic values of resistance

TSM concrete screw size				6		8			10			12			14			
Nominal embedment depth				$h_{nom}$	1	2	1	2	3	1	2	3	1	2	3	1	2	3
				[mm]	40	55	45	55	65	55	75	85	65	85	100	75	100	115
<b>Steel failure for tension and shear load</b>																		
characteristic Resistance	R30	$N_{Rk,s,fi30}$	[kN]	0,9		2,4			4,4			7,3			10,3			
	R60	$N_{Rk,s,fi60}$	[kN]	0,8		1,7			3,3			5,8			8,2			
	R90	$N_{Rk,s,fi90}$	[kN]	0,6		1,1			2,3			4,2			5,9			
	R120	$N_{Rk,s,fi120}$	[kN]	0,4		0,7			1,7			3,4			4,8			
	R30	$V_{Rk,s,fi30}$	[kN]	0,9		2,4			4,4			7,3			10,3			
	R60	$V_{Rk,s,fi60}$	[kN]	0,8		1,7			3,3			5,8			8,2			
	R90	$V_{Rk,s,fi90}$	[kN]	0,6		1,1			2,3			4,2			5,9			
	R120	$V_{Rk,s,fi120}$	[kN]	0,4		0,7			1,7			3,4			4,8			
	R30	$M^0_{Rk,s,fi30}$	[Nm]	0,7		2,4			5,9			12,3			20,4			
	R60	$M^0_{Rk,s,fi60}$	[Nm]	0,6		1,8			4,5			9,7			15,9			
	R90	$M^0_{Rk,s,fi90}$	[Nm]	0,5		1,2			3,0			7,0			11,6			
	R120	$M^0_{Rk,s,fi120}$	[Nm]	0,3		0,9			2,3			5,7			9,4			
<b>Pull-out failure</b>																		
Characteristic Resistance	R30- R90	$N_{Rk,p,fi}$	[kN]	0,5	1,0	1,3	2,3	3,0	2,3	4,0	4,8	3,0	4,7	6,2	3,8	6,0	7,6	
	R120	$N_{Rk,p,fi}$	[kN]	0,4	0,8	1,0	1,8	2,4	1,8	3,2	3,9	2,4	3,8	4,9	3,0	4,8	6,1	
<b>Concrete cone failure</b>																		
Characteristic Resistance	R30- R90	$N^0_{Rk,c,fi}$	[kN]	0,9	2,2	1,2	2,1	3,4	2,1	4,8	6,6	3,0	6,3	9,9	4,4	9,6	14,0	
	R120	$N^0_{Rk,c,fi}$	[kN]	0,7	1,8	1,0	1,7	2,7	1,7	3,8	5,3	2,4	5,1	7,9	3,5	7,6	11,2	
<b>Edge distance</b>																		
R30 bis R120	$c_{cr,fi}$	[mm]	$2 \times h_{ef}$															
In case of fire attack from more than one side, the minimum edge distance shall be $\geq 300$ mm.																		
<b>Spacing</b>																		
R30 bis R120	$s_{cr,fi}$	[mm]	$4 \times h_{ef}$															
<b>Pry-out failure</b>																		
R30 bis R120	$k_g$	[-]	1,0			2,0			1,0	2,0			1,0	2,0				
The anchorage depth has to be increased for wet concrete by at least 30 mm compared to the given value.																		
<b>TOGE concrete screw TSM high Performance</b>															<b>Annex C6</b>			
<b>Performances</b> Fire exposure – characteristic values of resistance																		

Table 12: Displacements under static and quasi-static tension load

TSM concrete screw size				6			8			10		
Nominal embedment depth				$h_{nom}$	$h_{nom1}$	$h_{nom2}$	$h_{nom1}$	$h_{nom2}$	$h_{nom3}$	$h_{nom1}$	$h_{nom2}$	$h_{nom3}$
				[mm]	40	55	45	55	65	55	75	85
Cracked concrete	tension load	N	[kN]	0,95	1,9	2,4	4,3	5,7	4,3	7,9	9,6	
	displacement	$\delta_{NO}$	[mm]	0,3	0,6	0,6	0,7	0,8	0,6	0,5	0,9	
		$\delta_{N\infty}$	[mm]	0,4	0,4	0,6	1,0	0,9	0,4	1,2	1,2	
Uncracked concrete	tension load	N	[kN]	1,9	4,3	3,6	5,7	7,6	5,7	9,5	11,9	
	displacement	$\delta_{NO}$	[mm]	0,4	0,6	0,7	0,9	0,5	0,7	1,1	1,0	
		$\delta_{N\infty}$	[mm]	0,4	0,4	0,6	1,0	0,9	0,4	1,2	1,2	

TSM concrete screw size				12			14			
Nominal embedment depth				$h_{nom}$	$h_{nom1}$	$h_{nom2}$	$h_{nom3}$	$h_{nom1}$	$h_{nom2}$	$h_{nom3}$
				[mm]	65	85	100	75	100	115
Cracked concrete	tension load	N	[kN]	5,7	9,4	12,3	7,6	12,0	15,1	
	displacement	$\delta_{NO}$	[mm]	0,9	0,5	1,0	0,5	0,8	0,7	
		$\delta_{N\infty}$	[mm]	1,0	1,2	1,2	0,9	1,2	1,0	
Uncracked concrete	tension load	N	[kN]	7,6	13,2	17,2	10,6	16,9	21,2	
	displacement	$\delta_{NO}$	[mm]	1,0	1,1	1,2	0,9	1,2	0,8	
		$\delta_{N\infty}$	[mm]	1,0	1,2	1,2	0,9	1,2	1,0	

Table 13: Displacements under static and quasi-static shear load

TSM concrete screw size				6			8			10		
Nominal embedment depth				$h_{nom}$	$h_{nom1}$	$h_{nom2}$	$h_{nom1}$	$h_{nom2}$	$h_{nom3}$	$h_{nom1}$	$h_{nom2}$	$h_{nom3}$
				[mm]	40	55	45	55	65	55	75	85
Cracked and uncracked concrete	shear load	V	[kN]	3,3			8,6			16,2		
	displacement	$\delta_{V0}$	[mm]	1,55			2,7			2,7		
		$\delta_{V\infty}$	[mm]	3,1			4,1			4,3		

TSM concrete screw size				12			14			
Nominal embedment depth				$h_{nom}$	$h_{nom1}$	$h_{nom2}$	$h_{nom3}$	$h_{nom1}$	$h_{nom2}$	$h_{nom3}$
				[mm]	65	85	100	75	100	115
Cracked and uncracked concrete	shear load	V	[kN]	20,0			30,5			
	displacement	$\delta_{V0}$	[mm]	4,0			3,1			
		$\delta_{V\infty}$	[mm]	6,0			4,7			

TOGE concrete screw TSM high Performance

**Performances**  
Displacements under static and quasi-static loads

**Annex C7**

Table 14: Seismic category C2 <sup>1)</sup> – Displacements **with filled annular gap** according to annex B7, figure 5 (type S, type ST, type P)

TSM concrete screw size			8	10	12	14
Nominal embedment depth	$h_{nom}$	$h_{nom3}$				
	[mm]	65	85	100	115	
Displacements under tension loads (version <b>type S, type ST, type P</b> )						
Displacement DLS	$\delta_{N,eq(DLS)}$	[mm]	0,66	0,32	0,57	1,16
Displacement ULS	$\delta_{N,eq(ULS)}$	[mm]	1,74	1,36	2,36	4,39
Displacements under shear loads (version <b>type S, type ST, type P</b> with hole clearance)						
Displacement DLS	$\delta_{V,eq(DLS)}$	[mm]	1,68	2,91	1,88	2,42
Displacement ULS	$\delta_{V,eq(ULS)}$	[mm]	5,19	6,72	5,37	9,27

Table 15: Seismic category C2 <sup>1)</sup> – Displacements **without filled annular gap** according to annex B5 (type S, type SK, type ST, type P)

TSM concrete screw size			8	10	12	14
Nominal embedment depth	$h_{nom}$	$h_{nom3}$				
	[mm]	65	85	100	115	
Displacements under tension loads (version <b>type S, type ST, type P</b> )						
Displacement DLS	$\delta_{N,eq(DLS)}$	[mm]	0,66	0,32	0,57	1,16
Displacement ULS	$\delta_{N,eq(ULS)}$	[mm]	1,74	1,36	2,36	4,39
Displacements under tension loads (version <b>type SK</b> )						
Displacement DLS	$\delta_{N,eq(DLS)}$	[mm]	0,66	0,32	no performance assessed	
Displacement ULS	$\delta_{N,eq(ULS)}$	[mm]	1,74	1,36		
Displacements under shear loads (version <b>type S, type ST, type P</b> with hole clearance)						
Displacement DLS	$\delta_{V,eq(DLS)}$	[mm]	4,21	4,71	4,42	5,60
Displacement ULS	$\delta_{V,eq(ULS)}$	[mm]	7,13	8,83	6,95	12,63
Displacements under shear loads (version <b>type SK</b> with hole clearance)						
Displacement DLS	$\delta_{V,eq(DLS)}$	[mm]	2,51	2,98	no performance assessed	
Displacement ULS	$\delta_{V,eq(ULS)}$	[mm]	7,76	6,25		

<sup>1)</sup> A4 and HCR not suitable

TOGE concrete screw TSM high Performance

**Performances**  
Displacements under seismic loads

**Annex C8**